

Zyklop.
¡La nueva generación!





Cada vez más usuarios exigen herramientas que sirvan para situaciones de montaje con muy poco espacio. Las máquinas y las piezas son cada vez más compactas, por eso las herramientas usuales son demasiado grandes para poder hacer un buen trabajo en ciertas circunstancias. Desde el año 2008 la carraca Zyklus está en el mercado, y ahora se ofrecerá una ampliación de esta familia de productos. Habrá dos carracas más, increíblemente delgadas y esbeltas pero, sin embargo, sumamente robustas, que de ahora en adelante resultarán imprescindibles para el usuario.

Dentro de la gama de productos de Wera, estas nuevas carracas formarán parte de la familia Zyklus, la famosa carraca que ya se conoce desde el año 2008.



Zyklus Speed

Lo especial de la carraca original Zyklus es el hecho de que aún a 5 tipos de carraca en una sola herramienta, y además su gran velocidad de trabajo. Ambas características conllevan una enorme ventaja en materia de esfuerzo y tiempo durante el trabajo, así que a partir de ahora, la Zyklus clásica llevará el nombre de Zyklus Speed.



Zyklop Metal

Las dos carracas nuevas son completamente metálicas (cromo-molibdeno), por lo tanto recibirán el nombre de Zyklop Metal. Habrá una diferenciación entre Zyklop Metal con cuadradillo pasante y Zyklop Metal con palanca de inversión de giro.

Zyklop Mini

La carraca de puntas combina un diseño filigrano con tremenda robustez. Para trabajos de atornillado especialmente rápidos, también en situaciones de trabajo de gran estrechez.

Koloss

La carraca que también se puede utilizar correctamente como martillo. El Koloss sirve como carraca reversible, así como de carraca de altas cargas con una capacidad de al menos 600 newtonmetros.



Hemos inventado una nueva compactibilidad.

Gracias a un novedoso concepto de estuche de Wera, ahora es mucho más cómodo llevar un juego de carracas durante el trabajo. Hasta ahora, los juegos de carracas y los accesorios se encontraban en unas cajas que si bien eran muy estables, también eran relativamente pesadas y voluminosas.

Ahora, las novedosas cajas son de un material textil muy liviano lo que significa una gran ventaja en cuanto a la movilidad y el espacio necesario. La misma cantidad de herramientas que hasta ahora tenía que sujetarse al menos con una mano por un asa, ahora se tiene en una caja compacta que a su vez puede convertirse en parte de una caja grande de herramientas en la cual se pueden transportar muchas otras herramientas más. A partir de ahora mismo, ya no hace falta que el técnico se mueva varias veces de un lado a otro para transportar la herramienta. Y el hecho de que un juego de carracas pese claramente menos hace mucho más cómodo el llevar la herramienta consigo. Incluso si se deja caer, la caja de material de tela queda intacta al igual que la herramienta que lleva. Y además: no deja huella alguna de rasguños en superficies delicadas.



Zyklop Metal

Extremamente delgada. Una palanca larga.

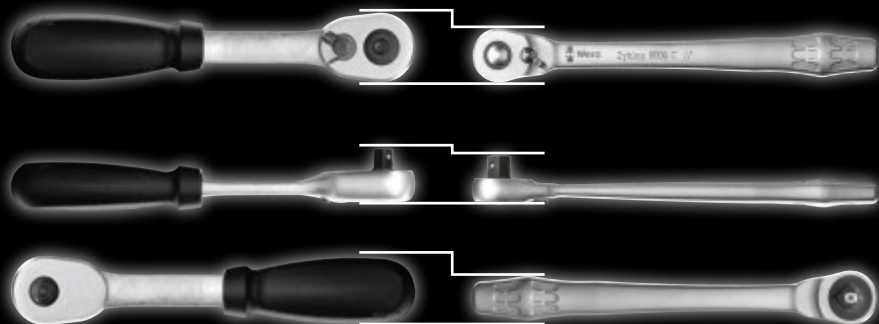

Gran robustez sin limitación del par de apriete.
Carraca forjada enteramente de metal de cromo-molibdeno.

8003 cuadrado pasante

Trabajos de apriete o desapriete normalmente se realizan en una sólo dirección. Al trabajar con una carraca puede ocurrir una conmutación del sentido de forma indeseada. El cuadrado pasante imperdible con su fijación segura del vaso, evita este cambio del sentido de giro indeseado.



una conmutación
extremamente
suave



una sujeción
del vaso super-
seguro



un ángulo de
recuperación muy
pequeño



cajas compactas
de material textil

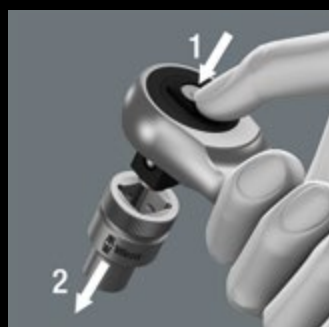



8004 palanca de inversión de giro

- Un cambio del sentido de giro muy cómodo gracias a la palanca de reenvío
- Con función segura de bloqueo de vaso



SWITCH

palanca de reenvío



UNLOCK

una sujeción del vaso super-seguro



FINE TOOTH

un ángulo de recuperación muy pequeño



ULTRA COMPACT

cajas compactas de material textil



La gama

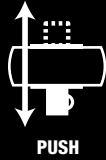

Carraca 8003 A Zyklop Metal, con cuadradillo pasante de 1/4"



Code				
	mm	mm	mm	mm
05004003001	1/4"	141,0	21	22



Carraca 8003 B Zyklop Metal, con cuadradillo pasante de 3/8"



Code				
	mm	mm	mm	mm
05004033001	3/8"	222,0	27	29

Juego de carraca 8100 SA 7 Zyklop Metal, cuadradillo pasante de 1/4", métrico

28 piezas

Code		
05004017001	8003 A	1 x 1/4"x141,0
	8790 HMA	1 x 5,0x23,0; 1 x 5,5x23,0; 1 x 6,0x23,0; 1 x 7,0x23,0; 1 x 8,0x23,0; 1 x 10,0x23,0; 1 x 11,0x23,0; 1 x 12,0x23,0; 1 x 13,0x23,0
	8794 LA	1 x 1/4"x150,0
	8794 A	1 x 1/4"x56,0
	8784 A1	1 x 1/4"x1/4"x37,0
	851/1 Z PH	1 x PH 1x25; 1 x PH 2x25; 1 x PH 3x25
	855/1 Z PZ	1 x PZ 1x25; 1 x PZ 2x25
	867/1 Z TORX®	1 x TX 10x25; 1 x TX 15x25; 1 x TX 20x25; 1 x TX 25x25; 1 x TX 27x25; 1 x TX 30x25
	840/1 Z Hex-Plus	1 x 3,0x25; 1 x 4,0x25; 1 x 5,0x25; 1 x 6,0x25

Carraca 8003 C Zyklop Metal, con cuadradillo pasante de 1/2"



Code				
	mm	mm	mm	mm
05004063001	1/2"	281,0	36	37

Juego de carraca 8100 SA 10 Zyklop Metal, cuadradillo pasante de 1/4", imperial

28 piezas

Code		
05004020001	8003 A	1 x 1/4"x141,0
	8790 HMA	1 x 3/16"x23,0; 1 x 7/32"x23,0; 1 x 1/4"x23,0; 1 x 9/32"x23,0; 1 x 5/16"x23,0; 1 x 11/32"x23,0; 1 x 3/8"x23,0; 1 x 7/16"x23,0; 1 x 1/2"x23,0
	8794 LA	1 x 1/4"x150,0
	8794 A	1 x 1/4"x56,0
	8784 A1	1 x 1/4"x1/4"x37,0
	851/1 Z PH	1 x PH 1x25; 1 x PH 2x25; 1 x PH 3x25
	855/1 Z PZ	1 x PZ 1x25; 1 x PZ 2x25
	867/1 Z TORX®	1 x TX 10x25; 1 x TX 15x25; 1 x TX 20x25; 1 x TX 25x25; 1 x TX 27x25; 1 x TX 30x25
	840/1 Z Hex-Plus	1 x 5/32"x25; 1 x 3/16"x25; 1 x 7/32"x25; 1 x 1/4"x25

NUEVO: Todas las puntas que se ofrecen en los juegos Zyklop disponen de una protección anticorrosiva duradera especial.



Juego de carraca 8100 SB 7 Zyklop Metal, cuadradillo pasante de 3/8", métrico

29 piezas

Code		
05004047001	● 8003 B	1 x 3/8"x222,0
	● 8790 HMB	1 x 8,0x29,0; 1 x 10,0x29,0; 1 x 12,0x29,0; 1 x 13,0x29,0; 1 x 15,0x29,0; 1 x 16,0x30,0; 1 x 17,0x30,0; 1 x 18,0x30,0; 1 x 19,0x30,0
	● 8794 LB	1 x 3/8"x200,0
	● 8794 B	1 x 3/8"x76,0
	● 8784 B1	1 x 1/4"x3/8"x44,0
	⊕ 851/1 Z PH	1 x PH 1x25; 1 x PH 2x25; 1 x PH 3x25
	⊕ 855/1 Z PZ	1 x PZ 1x25; 1 x PZ 2x25
	⊕ 867/1 Z TORX®	1 x TX 15x25; 1 x TX 20x25; 1 x TX 25x25; 1 x TX 27x25; 1 x TX 30x25; 1 x TX 40x25
	○ 840/1 Z Hex-Plus	1 x 3,0x25; 1 x 4,0x25; 1 x 5,0x25; 1 x 6,0x25; 1 x 8,0x25



Juego de carraca 8100 SC 7 Zyklop Metal, cuadradillo pasante de 1/2", métrico

28 piezas

Code		
05004077001	● 8003 C	1 x 1/2"x281,0
	● 8790 HMC	1 x 10,0x37,0; 1 x 11,0x37,0; 1 x 12,0x37,0; 1 x 13,0x37,0; 1 x 14,0x37,0; 1 x 15,0x37,0; 1 x 16,0x37,0; 1 x 17,0x37,0; 1 x 18,0x37,0; 1 x 19,0x37,0
	● 8794 LC	1 x 1/2"x250,0
	● 8794 C	1 x 1/2"x52,0
	● 8784 C2	1 x 5/16"x1/2"x50,0
	⊕ 851/2 Z PH	1 x PH 2x32; 1 x PH 3x32
	⊕ 867/2 Z TORX®	1 x TX 20x35; 1 x TX 25x35; 1 x TX 27x35; 1 x TX 30x35; 1 x TX 40x35; 1 x TX 45x35; 1 x TX 50x35; 1 x TX 55x35
	○ 840/2 Z	1 x 5x30; 1 x 6x30; 1 x 8x30; 1 x 10x30

Juego de carraca 8100 SB 10 Zyklop Metal, cuadradillo pasante de 3/8", imperial

29 piezas

Code		
05004050001	● 8003 B	1 x 3/8"x222,0
	● 8790 HMB	1 x 1/4"x29,0; 1 x 5/16"x29,0; 1 x 3/8"x29,0; 1 x 7/16"x29,0; 1 x 1/2"x29,0; 1 x 9/16"x29,0; 1 x 5/8"x30,0; 1 x 11/16"x30,0; 1 x 3/4"x30,0
	● 8794 LB	1 x 3/8"x200,0
	● 8794 B	1 x 3/8"x76,0
	● 8784 B1	1 x 1/4"x3/8"x44,0
	⊕ 851/1 Z PH	1 x PH 1x25; 1 x PH 2x25; 1 x PH 3x25
	⊕ 855/1 Z PZ	1 x PZ 1x25; 1 x PZ 2x25
	⊕ 867/1 Z TORX®	1 x TX 15x25; 1 x TX 20x25; 1 x TX 25x25; 1 x TX 27x25; 1 x TX 30x25; 1 x TX 40x25
	○ 840/1 Z Hex-Plus	1 x 5/32"x25; 1 x 3/16"x25; 1 x 7/32"x25; 1 x 1/4"x25; 1 x 5/16"x25

Juego de carraca 8100 SC 10 Zyklop Metal, cuadradillo pasante de 1/2", imperial





28 piezas

Code		
05004080001	● 8003 C	1 x 1/2"x281,0
	● 8790 HMC	1 x 3/8"x37,0; 1 x 7/16"x37,0; 1 x 1/2"x37,0; 1 x 9/16"x37,0; 1 x 19/32"x37,0; 1 x 5/8"x37,0; 1 x 11/16"x37,0; 1 x 3/4"x37,0; 1 x 25/32"x37,0; 1 x 13/16"x37,0
	● 8794 LC	1 x 1/2"x250,0
	● 8794 C	1 x 1/2"x52,0
	● 8784 C2	1 x 5/16"x1/2"x50,0
	⊕ 851/2 Z PH	1 x PH 2x32; 1 x PH 3x32
	⊕ 867/2 Z TORX®	1 x TX 20x35; 1 x TX 25x35; 1 x TX 27x35; 1 x TX 30x35; 1 x TX 40x35; 1 x TX 45x35; 1 x TX 50x35; 1 x TX 55x35
	○ 840/2 Z	1 x 7/32"x30; 1 x 1/4"x30; 1 x 5/16"x30; 1 x 3/8"x30

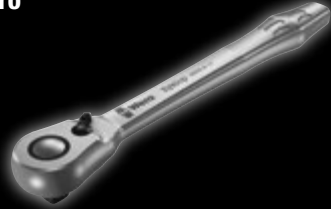
La gama





Carraca 8004 A Zyklop Metal, cuadradillo de 1/4" y con palanca de inversión de giro



Code				
	mm	mm	mm	
05004004001	1/4"	141,0	19	22





Carraca 8004 B Zyklop Metal, cuadradillo de 3/8" y con palanca de inversión de giro



Code				
	mm	mm	mm	
05004034001	3/8"	222,0	26	29









Carraca 8004 C Zyklop Metal, cuadradillo de 1/2" y con palanca de inversión de giro



Code				
	mm	mm	mm	
05004064001	1/2"	281,0	34	37









Juego de carraca 8100 SA 8 Zyklop Metal, cuadradillo de 1/4" y palanca de inversión de giro, métrico

28 piezas

Code		
05004018001	 8004 A	1 x 1/4"x141,0
	 8790 HMA	1 x 5,0x23,0; 1 x 5,5x23,0; 1 x 6,0x23,0; 1 x 7,0x23,0; 1 x 8,0x23,0; 1 x 10,0x23,0; 1 x 11,0x23,0; 1 x 12,0x23,0; 1 x 13,0x23,0
	 8794 LA	1 x 1/4"x150,0
	 8794 A	1 x 1/4"x56,0
	 8784 A1	1 x 1/4"x1/4"x37,0
	 851/1 Z PH	1 x PH 1x25; 1 x PH 2x25; 1 x PH 3x25
	 855/1 Z PZ	1 x PZ 1x25; 1 x PZ 2x25
	 867/1 Z TORX®	1 x TX 10x25; 1 x TX 15x25; 1 x TX 20x25; 1 x TX 25x25; 1 x TX 27x25; 1 x TX 30x25
	 840/1 Z Hex-Plus	1 x 3,0x25; 1 x 4,0x25; 1 x 5,0x25; 1 x 6,0x25

Juego de carraca 8100 SA 11 Zyklop Metal, cuadradillo de 1/4" y palanca de inversión de giro, imperial

28 piezas

Code		
05004021001	 8004 A	1 x 1/4"x141,0
	 8790 HMA	1 x 3/16"x23,0; 1 x 7/32"x23,0; 1 x 1/4"x23,0; 1 x 9/32"x23,0; 1 x 5/16"x23,0; 1 x 11/32"x23,0; 1 x 3/8"x23,0; 1 x 7/16"x23,0; 1 x 1/2"x23,0
	 8794 LA	1 x 1/4"x150,0
	 8794 A	1 x 1/4"x56,0
	 8784 A1	1 x 1/4"x1/4"x37,0
	 851/1 Z PH	1 x PH 1x25; 1 x PH 2x25; 1 x PH 3x25
	 855/1 Z PZ	1 x PZ 1x25; 1 x PZ 2x25
	 867/1 Z TORX®	1 x TX 10x25; 1 x TX 15x25; 1 x TX 20x25; 1 x TX 25x25; 1 x TX 27x25; 1 x TX 30x25
	 840/1 Z Hex-Plus	1 x 5/32"x25; 1 x 3/16"x25; 1 x 7/32"x25; 1 x 1/4"x25

NUEVO: Todas las puntas que se ofrecen en los juegos Zyklop disponen de una protección anticorrosiva duradera especial.



Juego de carraca 8100 SB 8 Zyklop Metal, cuadradillo de 3/8" y palanca de inversión de giro, métrico

29 piezas

Code		
05004048001	● 8004 B	1 x 3/8"x222,0
	● 8790 HMB	1 x 8,0x29,0; 1 x 10,0x29,0; 1 x 12,0x29,0; 1 x 13,0x29,0; 1 x 15,0x29,0; 1 x 16,0x30,0; 1 x 17,0x30,0; 1 x 18,0x30,0; 1 x 19,0x30,0
	● 8794 LB	1 x 3/8"x200,0
	● 8794 B	1 x 3/8"x76,0
	● 8784 B1	1 x 1/4"x3/8"x44,0
	⊕ 851/1 Z PH	1 x PH 1x25; 1 x PH 2x25; 1 x PH 3x25
	⊕ 855/1 Z PZ	1 x PZ 1x25; 1 x PZ 2x25
	⊕ 867/1 Z TORX®	1 x TX 15x25; 1 x TX 20x25; 1 x TX 25x25; 1 x TX 27x25; 1 x TX 30x25; 1 x TX 40x25
	○ 840/1 Z Hex-Plus	1 x 3,0x25; 1 x 4,0x25; 1 x 5,0x25; 1 x 6,0x25; 1 x 8,0x25



Juego de carraca 8100 SC 8 Zyklop Metal, cuadradillo de 1/2" y palanca de inversión de giro, métrico

28 piezas

Code		
05004078001	● 8004 C	1 x 1/2"x281,0
	● 8790 HMC	1 x 10,0x37,0; 1 x 11,0x37,0; 1 x 12,0x37,0; 1 x 13,0x37,0; 1 x 14,0x37,0; 1 x 15,0x37,0; 1 x 16,0x37,0; 1 x 17,0x37,0; 1 x 18,0x37,0; 1 x 19,0x37,0
	● 8794 LC	1 x 1/2"x250,0
	● 8794 C	1 x 1/2"x52,0
	● 8784 C2	1 x 5/16"x1/2"x50,0
	⊕ 851/2 Z PH	1 x PH 2x32; 1 x PH 3x32
	⊕ 867/2 Z TORX®	1 x TX 20x35; 1 x TX 25x35; 1 x TX 27x35; 1 x TX 30x35; 1 x TX 40x35; 1 x TX 45x35; 1 x TX 50x35; 1 x TX 55x35
	○ 840/2 Z	1 x 5x30; 1 x 6x30; 1 x 8x30; 1 x 10x30

Juego de carraca 8100 SB 11 Zyklop Metal, cuadradillo de 3/8" y palanca de inversión de giro, imperial

29 piezas

Code		
05004051001	● 8004 B	1 x 3/8"x222,0
	● 8790 HMB	1 x 1/4"x29,0; 1 x 5/16"x29,0; 1 x 3/8"x29,0; 1 x 7/16"x29,0; 1 x 1/2"x29,0; 1 x 9/16"x29,0; 1 x 5/8"x30,0; 1 x 11/16"x30,0; 1 x 3/4"x30,0
	● 8794 LB	1 x 3/8"x200,0
	● 8794 B	1 x 3/8"x76,0
	● 8784 B1	1 x 1/4"x3/8"x44,0
	⊕ 851/1 Z PH	1 x PH 1x25; 1 x PH 2x25; 1 x PH 3x25
	⊕ 855/1 Z PZ	1 x PZ 1x25; 1 x PZ 2x25
	⊕ 867/1 Z TORX®	1 x TX 15x25; 1 x TX 20x25; 1 x TX 25x25; 1 x TX 27x25; 1 x TX 30x25; 1 x TX 40x25
	○ 840/1 Z Hex-Plus	1 x 5/32"x25; 1 x 3/16"x25; 1 x 7/32"x25; 1 x 1/4"x25; 1 x 5/16"x25

Juego de carraca 8100 SC 11 Zyklop Metal, cuadradillo de 1/2" y palanca de inversión de giro, imperial

28 piezas

Code		
05004081001	● 8004 C	1 x 1/2"x281,0
	● 8790 HMC	1 x 3/8"x37,0; 1 x 7/16"x37,0; 1 x 1/2"x37,0; 1 x 9/16"x37,0; 1 x 19/32"x37,0; 1 x 5/8"x37,0; 1 x 11/16"x37,0; 1 x 3/4"x37,0; 1 x 25/32"x37,0; 1 x 13/16"x37,0
	● 8794 LC	1 x 1/2"x250,0
	● 8794 C	1 x 1/2"x52,0
	● 8784 C2	1 x 5/16"x1/2"x50,0
	⊕ 851/2 Z PH	1 x PH 2x32; 1 x PH 3x32
	⊕ 867/2 Z TORX®	1 x TX 20x35; 1 x TX 25x35; 1 x TX 27x35; 1 x TX 30x35; 1 x TX 40x35; 1 x TX 45x35; 1 x TX 50x35; 1 x TX 55x35
	○ 840/2 Z	1 x 7/32"x30; 1 x 1/4"x30; 1 x 5/16"x30; 1 x 3/8"x30

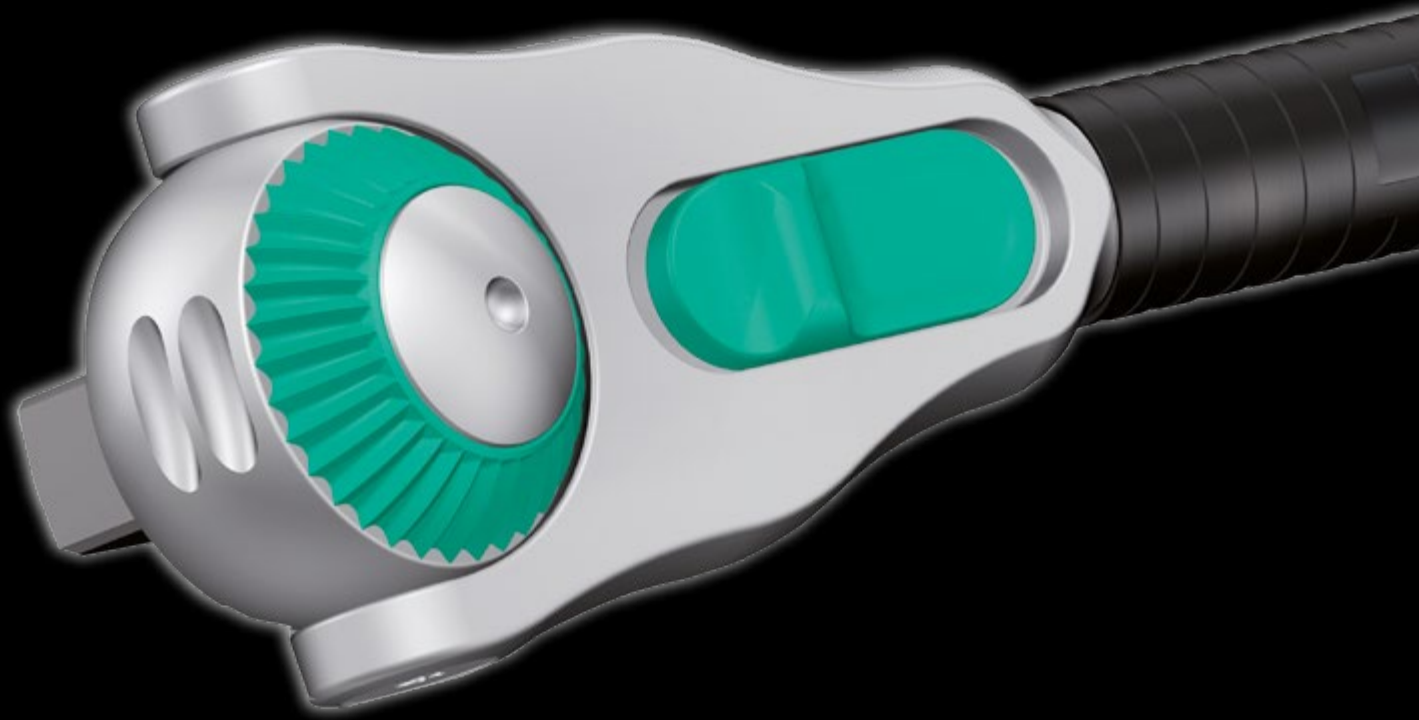

Zyklop Speed

Las carracas Zyklop son unos verdaderos milagros en rapidez:

Zyklop "6 en 1"

Con la carraca Zyklop usted tendrá 5 tipos de carraca en una sólo – e incluso puede utilizarla como si fuera un destornillador.

1. Carraca con dentado fino
2. Carraca articulada
3. Carraca flexible
4. Carraca con bloqueo de vaso
5. Carraca de potencia

En la posición de 0°, con ayuda de un adaptador y una punta, la carraca se puede utilizar como si fuera un destornillador convencional.



SPEED

una alta velocidad de trabajo



FLEXIBLE HEAD

la cabeza de la carraca es libremente giratoria



FINE TOOTH

un ángulo de recuperación muy pequeño



SWITCH

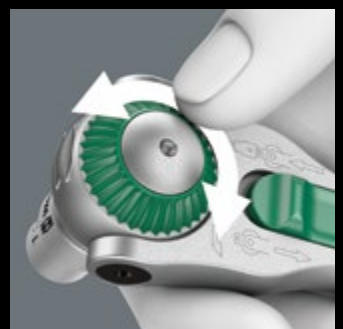

conmutable



La gama Zyklop Speed



8000 A Carraca Zyklop Speed con cuadradillo de 1/4"



Code			mm
05003500001	1/4"	152.0	



8000 B Carraca Zyklop Speed con cuadradillo de 3/8"



Code			mm
05003550001	3/8"	199.0	

8000 C Carraca Zyklop Speed con cuadradillo de 1/2"



Code			mm
05003600001	1/2"	277.0	



Juegos Zyklop Speed en cajas de material textil



Juego de carraca 8100 SA 6 Zyklop Speed, cuadradillo de 1/4", métrico

28 piezas

Code		
05004016001	8000 A	1 x 1/4"x152,0
	8790 HMA	1 x 5,0x23,0; 1 x 5,5x23,0; 1 x 6,0x23,0; 1 x 7,0x23,0; 1 x 8,0x23,0; 1 x 10,0x23,0; 1 x 11,0x23,0; 1 x 12,0x23,0; 1 x 13,0x23,0
	8794 LA	1 x 1/4"x150,0
	8794 A	1 x 1/4"x56,0
	8784 A1	1 x 1/4"x1/4"x37,0
	851/4 TZ PH	1 x PH 1x50; 1 x PH 2x50; 1 x PH 3x50
	855/4 TZ PZ	1 x PZ 1x50; 1 x PZ 2x50
	867/4 Z TORX®	1 x TX 10x50; 1 x TX 15x50; 1 x TX 20x50; 1 x TX 25x50; 1 x TX 27x50; 1 x TX 30x50
	840/4 Z Hex-Plus	1 x 3,0x50; 1 x 4,0x50; 1 x 5,0x50; 1 x 6,0x50



Juego de carraca 8100 SB 6 Zyklop Speed cuadradillo de 3/8", métrico

29 piezas

Code		
05004046001	8000 B	1 x 3/8"x199,0
	8790 HMB	1 x 8,0x29,0; 1 x 10,0x29,0; 1 x 12,0x29,0; 1 x 13,0x29,0; 1 x 15,0x29,0; 1 x 16,0x30,0; 1 x 17,0x30,0; 1 x 18,0x30,0; 1 x 19,0x30,0
	8794 LB	1 x 3/8"x200,0
	8794 B	1 x 3/8"x76,0
	8784 B1	1 x 1/4"x3/8"x44,0
	851/4 TZ PH	1 x PH 1x50; 1 x PH 2x50; 1 x PH 3x50
	855/4 TZ PZ	1 x PZ 1x50; 1 x PZ 2x50; 1 x PZ 3x50
	867/4 Z TORX®	1 x TX 20x50; 1 x TX 25x50; 1 x TX 27x50; 1 x TX 30x50; 1 x TX 40x50
	840/4 Z Hex-Plus	1 x 4,0x50; 1 x 5,0x50; 1 x 6,0x50; 1 x 8,0x50
	800/4 Z	1 x 1,0x5,5x50

Juego de carraca 8100 SA 9 Zyklop Speed, cuadradillo de 1/4", imperial

28 piezas

Code		
05004019001	8000 A	1 x 1/4"x152,0
	8790 HMA	1 x 3/16"x23,0; 1 x 7/32"x23,0; 1 x 1/4"x23,0; 1 x 9/32"x23,0; 1 x 5/16"x23,0; 1 x 11/32"x23,0; 1 x 3/8"x23,0; 1 x 7/16"x23,0; 1 x 1/2"x23,0
	8794 LA	1 x 1/4"x150,0
	8794 A	1 x 1/4"x56,0
	8784 A1	1 x 1/4"x1/4"x37,0
	851/4 TZ PH	1 x PH 1x50; 1 x PH 2x50; 1 x PH 3x50
	855/4 TZ PZ	1 x PZ 1x50; 1 x PZ 2x50
	867/4 Z TORX®	1 x TX 10x50; 1 x TX 15x50; 1 x TX 20x50; 1 x TX 25x50; 1 x TX 27x50; 1 x TX 30x50
	840/4 Z Hex-Plus	1 x 5/32"x50; 1 x 3/16"x50; 1 x 7/32"x50; 1 x 1/4"x50

Juego de carraca 8100 SB 9 Zyklop Speed, cuadradillo de 3/8", imperial

29 piezas

Code		
05004049001	8000 B	1 x 3/8"x199,0
	8790 HMB	1 x 1/4"x29,0; 1 x 5/16"x29,0; 1 x 3/8"x29,0; 1 x 7/16"x29,0; 1 x 1/2"x29,0; 1 x 9/16"x29,0; 1 x 5/8"x30,0; 1 x 11/16"x30,0; 1 x 3/4"x30,0
	8794 LB	1 x 3/8"x200,0
	8794 B	1 x 3/8"x76,0
	8784 B1	1 x 1/4"x3/8"x44,0
	851/4 TZ PH	1 x PH 1x50; 1 x PH 2x50; 1 x PH 3x50
	855/4 TZ PZ	1 x PZ 1x50; 1 x PZ 2x50; 1 x PZ 3x50
	867/4 Z TORX®	1 x TX 20x50; 1 x TX 25x50; 1 x TX 27x50; 1 x TX 30x50; 1 x TX 40x50
	840/4 Z Hex-Plus	1 x 3/16"x50; 1 x 7/32"x50; 1 x 1/4"x50; 1 x 5/16"x50
	800/4 Z	1 x 1,0x5,5x50



Juego de carraca 8100 SC 6 Zyklop Speed cuadradillo de 1/2", métrico

28 piezas

Code		
05004076001	● 8000 C	1 x 1/2"x277,0
	● 8790 HMC	1 x 10,0x37,0; 1 x 11,0x37,0; 1 x 12,0x37,0; 1 x 13,0x37,0; 1 x 14,0x37,0; 1 x 15,0x37,0; 1 x 16,0x37,0; 1 x 17,0x37,0; 1 x 18,0x37,0; 1 x 19,0x37,0
	● 8794 LC	1 x 1/2"x250,0
	● 8794 C	1 x 1/2"x52,0
	● 8784 C2	1 x 5/16"x1/2"x50,0
	⊕ 851/2 Z PH	1 x PH 2x32; 1 x PH 3x32
	⊕ 855/2 Z PZ	1 x PZ 2x32; 1 x PZ 3x32
	⊕ 867/2 Z TORX®	1 x TX 20x35; 1 x TX 25x35; 1 x TX 30x35; 1 x TX 40x35; 1 x TX 45x35; 1 x TX 50x35
	○ 840/2 Z	1 x 5x30; 1 x 6x30; 1 x 8x30; 1 x 10x30

Juego de carraca 8100 SC 9 Zyklop Speed, cuadradillo de 1/2", imperial

28 piezas

Code		
05004079001	● 8000 C	1 x 1/2"x277,0
	● 8790 HMC	1 x 3/8"x37,0; 1 x 7/16"x37,0; 1 x 1/2"x37,0; 1 x 9/16"x37,0; 1 x 19/32"x37,0; 1 x 5/8"x37,0; 1 x 11/16"x37,0; 1 x 3/4"x37,0; 1 x 25/32"x37,0; 1 x 13/16"x37,0
	● 8794 LC	1 x 1/2"x250,0
	● 8794 C	1 x 1/2"x52,0
	● 8784 C2	1 x 5/16"x1/2"x50,0
	⊕ 851/2 Z PH	1 x PH 2x32; 1 x PH 3x32
	⊕ 855/2 Z PZ	1 x PZ 2x32; 1 x PZ 3x32
	⊕ 867/2 Z TORX®	1 x TX 20x35; 1 x TX 25x35; 1 x TX 30x35; 1 x TX 40x35; 1 x TX 45x35; 1 x TX 50x35
	○ 840/2 Z	1 x 7/32"x30; 1 x 1/4"x30; 1 x 5/16"x30; 1 x 3/8"x30



NUEVO: Todas las puntas que se ofrecen en los juegos Zyklop disponen de una protección anticorrosiva duradera especial.

Juegos Zyklop Speed en cajas met



8100 SA 1 Juego de carraca Zyklop Speed, 1/4", métrico
18 piezas

Code		
05003532001	8000 A	1 x 1/4"x152,0
	8789 A	1 x 1/4"x110,0
	8790 HMA	1 x 4,0x23,0; 1 x 4,5x23,0; 1 x 5,0x23,0; 1 x 5,5x23,0; 1 x 6,0x23,0; 1 x 7,0x23,0; 1 x 8,0x23,0; 1 x 9,0x23,0; 1 x 10,0x23,0; 1 x 11,0x23,0; 1 x 12,0x23,0; 1 x 13,0x23,0; 1 x 14,0x23,0
	8794 LA	1 x 1/4"x150,0
	8794 SA	1 x 1/4"x75,0
	8795 A	1 x 1/4"x35,5

8100 SA 3 Juego de carraca Zyklop Speed, 1/4", imperial
15 piezas

Code		
05003534001	8000 A	1 x 1/4"x152,0
	8789 A	1 x 1/4"x110,0
	8790 HMA	1 x 3/16"x23,0; 1 x 7/32"x23,0; 1 x 1/4"x23,0; 1 x 9/32"x23,0; 1 x 5/16"x23,0; 1 x 11/32"x23,0; 1 x 3/8"x23,0; 1 x 7/16"x23,0; 1 x 1/2"x23,0; 1 x 9/16"x23,0
	8794 LA	1 x 1/4"x150,0
	8794 SA	1 x 1/4"x75,0
	8795 A	1 x 1/4"x35,5

NUEVO: Todas las puntas que se ofrecen en los juegos Zyklop disponen de una protección anticorrosiva duradera especial.



8100 SA 2 Juego de carraca Zyklop Speed, 1/4" métrico
42 piezas

Code		
05003533001	8000 A	1 x 1/4"x152,0
	800/1 Z	1 x 0,6x4,5x25; 1 x 1,0x5,5x25; x 1,2x8,0x25
	840/1 Z Hex-Plus	1 x 3,0x25; 1 x 4,0x25; 1 x 5,0x25; 1 x 6,0x25; 1 x 8,0x25
	851/1 Z PH	1 x PH 1x25; 1 x PH 2x25; 1 x PH 3x25
	855/1 Z PZ	1 x PZ 1x25; 1 x PZ 2x25; 1 x PZ 3x25
	867/1 Z TORX® B0	1 x TX 8x25; 1 x TX 9x25; 1 x TX 10x25; 1 x TX 15x25; 1 x TX 20x25; 1 x TX 25x25; 1 x TX 30x25; 1 x TX 40x25
	8784 A1	1 x 1/4"x1/4"x37,0
	8789 A	1 x 1/4"x110,0
	8790 HMA	1 x 4,0x23,0; 1 x 4,5x23,0; 1 x 5,0x23,0; 1 x 5,5x23,0; 1 x 6,0x23,0; 1 x 7,0x23,0; 1 x 8,0x23,0; 1 x 9,0x23,0; 1 x 10,0x23,0; 1 x 11,0x23,0; 1 x 12,0x23,0; 1 x 13,0x23,0; 1 x 14,0x23,0
	8794 A	1 x 1/4"x56,0
	8795 A	1 x 1/4"x35,5
	8796 LA	1 x 1/4"x150,0
	8796 SA	1 x 1/4"x75,0

8100 SA 4 Juego de carraca Zyklop Speed, 1/4", imperial
41 piezas

Code		
05003535001	8000 A	1 x 1/4"x152,0
	800/1 Z	1 x 0,6x4,5x25; 1 x 1,0x5,5x25; 1 x 1,2x8,0x25
	840/1 Z Hex-Plus	1 x 5/64"x25; 1 x 3/32"x25; 1 x 1/8"x25; 1 x 9/64"x25; 1 x 5/32"x25; 1 x 3/16"x25; 1 x 7/32"x25
	851/1 Z PH	1 x PH 1x25; 1 x PH 2x25; 1 x PH 3x25
	855/1 Z PZ	1 x PZ 1x25; 1 x PZ 2x25; 1 x PZ 3x25
	867/1 Z TORX® B0	1 x TX 8x25; 1 x TX 9x25; 1 x TX 10x25; 1 x TX 15x25; 1 x TX 20x25; 1 x TX 25x25; 1 x TX 30x25; 1 x TX 40x25
	8784 A1	1 x 1/4"x1/4"x37,0
	8789 A	1 x 1/4"x110,0
	8790 HMA	1 x 3/16"x23,0; 1 x 7/32"x23,0; 1 x 1/4"x23,0; 1 x 9/32"x23,0; 1 x 5/16"x23,0; 1 x 11/32"x23,0; 1 x 3/8"x23,0; 1 x 7/16"x23,0; 1 x 1/2"x23,0; 1 x 9/16"x23,0
	8794 A	1 x 1/4"x56,0
	8795 A	1 x 1/4"x35,5
	8796 LA	1 x 1/4"x150,0
	8796 SA	1 x 1/4"x75,0

álicas robustas



8100 SB 1 Juego de carraca Zyklop Speed, 3/8" métrico

23 piezas

Code	
05003593001	<ul style="list-style-type: none"> ● 8000 B 1 x 3/8"x199.0 ● 8789 B 1 x 3/8"x165.0 ● 8790 HMB 1 x 6.0x29.0; 1 x 7.0x29.0; 1 x 8.0x29.0; 1 x 9.0x29.0; 1 x 10.0x29.0; 1 x 11.0x29.0; 1 x 12.0x29.0; 1 x 13.0x29.0; 1 x 14.0x29.0; 1 x 15.0x29.0; 1 x 16.0x30.0; 1 x 17.0x30.0; 1 x 18.0x30.0; 1 x 19.0x30.0; 1 x 20.0x30.0; 1 x 21.0x30.0; 1 x 22.0x30.0; 1 x 24.0x32.0 ● 8794 LB 1 x 3/8"x200.0 ● 8794 SB 1 x 3/8"x125.0 ● 8795 B 1 x 3/8"x50.0

8100 SB 3 Juego de carraca Zyklop Speed, 3/8", imperial

17 piezas

Code	
05003595001	<ul style="list-style-type: none"> ● 8000 B 1 x 3/8"x199.0 ● 8789 B 1 x 3/8"x165.0 ● 8790 HMB 1 x 1/4"x29.0; 1 x 5/16"x29.0; 1 x 11/32"x29.0; 1 x 3/8"x29.0; 1 x 7/16"x29.0; 1 x 1/2"x29.0; 1 x 9/16"x29.0; 1 x 5/8"x30.0; 1 x 11/16"x30.0; 1 x 3/4"x30.0; 1 x 13/16"x30.0; 1 x 7/8"x30.0 ● 8794 LB 1 x 3/8"x200.0 ● 8794 SB 1 x 3/8"x125.0 ● 8795 B 1 x 3/8"x50.0



8100 SB 2 Juego de carraca Zyklop Speed, 3/8" métrico

43 piezas

Code	
05003594001	<ul style="list-style-type: none"> ● 8000 B 1 x 3/8"x199.0 ● 800/1 Z 1 x 1.0x5.5x25 ● 840/1 Z Hex-Plus 1 x 3.0x25; 1 x 4.0x25; 1 x 5.0x25; 1 x 6.0x25; 1 x 8.0x25; 1 x 10.0x25 ● 851/1 Z PH 1 x PH 2x25; 1 x PH 3x25 ● 855/1 Z PZ 1 x PZ 2x25; 1 x PZ 3x25 ● 867/1 Z TORX® BO 1 x TX 10x25; 1 x TX 15x25; 1 x TX 20x25; 1 x TX 25x25; 1 x TX 27x25; 1 x TX 30x25; 1 x TX 40x25 ● 8784 B1 1 x 1/4"x3/8"x44.0 ● 8789 B 1 x 3/8"x165.0 ● 8790 HMB 1 x 6.0x29.0; 1 x 7.0x29.0; 1 x 8.0x29.0; 1 x 9.0x29.0; 1 x 10.0x29.0; 1 x 11.0x29.0; 1 x 12.0x29.0; 1 x 13.0x29.0; 1 x 14.0x29.0; 1 x 15.0x29.0; 1 x 16.0x30.0; 1 x 17.0x30.0; 1 x 18.0x30.0; 1 x 19.0x30.0; 1 x 20.0x30.0; 1 x 21.0x30.0; 1 x 22.0x30.0; 1 x 24.0x32.0 ● 8794 B 1 x 3/8"x76.0 ● 8795 B 1 x 3/8"x50.0 ● 8796 LB 1 x 3/8"x200.0 ● 8796 SB 1 x 3/8"x125.0

8100 SB 4 Juego de carraca Zyklop Speed, 3/8", imperial

38 piezas

Code	
05003596001	<ul style="list-style-type: none"> ● 800/1 Z 1 x 1.0x5.5x25 ● 840/1 Z Hex-Plus 1 x 5/64"x25; 1 x 3/32"x25; 1 x 1/8"x25; 1 x 9/64"x25; 1 x 5/32"x25; 1 x 3/16"x25; 1 x 7/32"x25 ● 851/1 Z PH 1 x PH 2x25; 1 x PH 3x25 ● 855/1 Z PZ 1 x PZ 2x25; 1 x PZ 3x25 ● 867/1 Z TORX® BO 1 x TX 10x25; 1 x TX 15x25; 1 x TX 20x25; 1 x TX 25x25; 1 x TX 27x25; 1 x TX 30x25; 1 x TX 40x25 ● 8784 B1 1 x 1/4"x3/8"x44.0 ● 8789 B 1 x 3/8"x165.0 ● 8790 HMB 1 x 1/4"x29.0; 1 x 5/16"x29.0; 1 x 11/32"x29.0; 1 x 3/8"x29.0; 1 x 7/16"x29.0; 1 x 1/2"x29.0; 1 x 9/16"x29.0; 1 x 5/8"x30.0; 1 x 11/16"x30.0; 1 x 3/4"x30.0; 1 x 13/16"x30.0; 1 x 7/8"x30.0 ● 8794 B 1 x 3/8"x76.0 ● 8795 B 1 x 3/8"x50.0 ● 8796 LB 1 x 3/8"x200.0 ● 8796 SB 1 x 3/8"x125.0



8100 SC 1 Juego de carraca Zyklop Speed, 1/2", métrico

22 piezas

Code	
05003644001	<ul style="list-style-type: none"> ● 8000 C 1 x 1/2"x277.0 ● 8789 C 1 x 1/2"x250.0 ● 8790 HMC 1 x 10.0x37.0; 1 x 11.0x37.0; 1 x 12.0x37.0; 1 x 13.0x37.0; 1 x 14.0x37.0; 1 x 15.0x37.0; 1 x 16.0x37.0; 1 x 17.0x37.0; 1 x 18.0x37.0; 1 x 19.0x37.0; 1 x 20.0x37.0; 1 x 21.0x37.0; 1 x 22.0x37.0; 1 x 24.0x37.0; 1 x 27.0x40.0; 1 x 30.0x42.0; 1 x 32.0x42.0 ● 8794 LC 1 x 1/2"x250.0 ● 8794 SC 1 x 1/2"x125.0 ● 8795 C 1 x 1/2"x69.0

8100 SC 3 Juego de carraca Zyklop Speed, 1/2", imperial

23 piezas

Code	
05003646001	<ul style="list-style-type: none"> ● 8000 C 1 x 1/2"x277.0 ● 8789 C 1 x 1/2"x250.0 ● 8790 HMC 1 x 3/8"x37.0; 1 x 7/16"x37.0; 1 x 1/2"x37.0; 1 x 9/16"x37.0; 1 x 19/32"x37.0; 1 x 5/8"x37.0; 1 x 11/16"x37.0; 1 x 3/4"x37.0; 1 x 25/32"x37.0; 1 x 13/16"x37.0; 1 x 7/8"x37.0; 1 x 15/16"x37.0; 1 x 31/32"x37.0; 1 x 1"x40.0; 1 x 1 1/16"x40.0; 1 x 1 1/8"x40.0; 1 x 1 3/16"x42.0; 1 x 1 1/4"x42.0 ● 8794 LC 1 x 1/2"x250.0 ● 8794 SC 1 x 1/2"x125.0 ● 8795 C 1 x 1/2"x69.0

NUEVO: Todas las puntas que se ofrecen en los juegos Zyklop disponen de una protección anticorrosiva duradera especial.



8100 SC 2 Juego de carraca Zyklop Speed, 1/2", métrico

37 piezas

Code	
05003645001	<ul style="list-style-type: none"> ● 8000 C 1 x 1/2"x277.0 ● 840/2 Z Hex-Plus 1 x 5x30; 1 x 6x30; 1 x 8x30; 1 x 10x30 ⊕ 851/2 Z PH 1 x PH 3x32 ⊕ 855/2 Z PZ 1 x PZ 3x32 ⊕ 867/2 Z TORX® 1 x TX 20x35; 1 x TX 25x35; 1 x TX 30x35; 1 x TX 40x35; 1 x TX 45x35; 1 x TX 50x35; 1 x TX 55x35 ● 8784 C2 1 x 1/2"x5/16"x50.0 ● 8789 C 1 x 1/2"x250.0 ● 8790 HMC 1 x 10.0x37.0; 1 x 11.0x37.0; 1 x 12.0x37.0; 1 x 13.0x37.0; 1 x 14.0x37.0; 1 x 15.0x37.0; 1 x 16.0x37.0; 1 x 17.0x37.0; 1 x 18.0x37.0; 1 x 19.0x37.0; 1 x 20.0x37.0; 1 x 21.0x37.0; 1 x 22.0x37.0; 1 x 24.0x37.0; 1 x 27.0x40.0; 1 x 30.0x42.0; 1 x 32.0x42.0 ● 8794 C 1 x 1/2"x52.0 ● 8795 C 1 x 1/2"x69.0 ● 8796 LC 1 x 1/2"x250.0 ● 8796 SC 1 x 1/2"x125.0

8100 SC 4 Juego de carraca Zyklop Speed, 1/2", imperial

38 piezas

Code	
05003647001	<ul style="list-style-type: none"> ● 8000 C 1 x 1/2"x277.0 ● 840/2 Z Hex-Plus 1 x 7/32"x30; 1 x 1/4"x30; 1 x 5/16"x30; 1 x 3/8"x30 ⊕ 851/2 Z PH 1 x PH 3x32 ⊕ 855/2 Z PZ 1 x PZ 3x32 ⊕ 867/2 Z TORX® 1 x TX 20x35; 1 x TX 25x35; 1 x TX 30x35; 1 x TX 40x35; 1 x TX 45x35; 1 x TX 50x35; 1 x TX 55x35 ● 8784 C2 1 x 1/2"x5/16"x50.0 ● 8789 C 1 x 1/2"x250.0 ● 8790 HMC 1 x 3/8"x37.0; 1 x 7/16"x37.0; 1 x 1/2"x37.0; 1 x 9/16"x37.0; 1 x 19/32"x37.0; 1 x 5/8"x37.0; 1 x 11/16"x37.0; 1 x 3/4"x37.0; 1 x 25/32"x37.0; 1 x 13/16"x37.0; 1 x 7/8"x37.0; 1 x 15/16"x37.0; 1 x 31/32"x37.0; 1 x 1"x40.0; 1 x 1 1/16"x40.0; 1 x 1 1/8"x40.0; 1 x 1 3/16"x42.0; 1 x 1 1/4"x42.0 ● 8794 C 1 x 1/2"x52.0 ● 8795 C 1 x 1/2"x69.0 ● 8796 LC 1 x 1/2"x250.0 ● 8796 SC 1 x 1/2"x125.0



8100 SA/SC 2 Juego de carraca Zyklop Speed con arrastre de ¼" y arrastre de ½", métrico

43 piezas

Code	
05160785001	<ul style="list-style-type: none"> ○ 8000 A 1 x 1/4"x152,0 ○ 8000 C 1 x 1/2"x277,0 ● 816 R 1 x 1/4"x119,0 ● 800/4 Z 1 x 1,0x5,5x89 ○ 840/4 Z Hex-Plus 1 x 3,0x89; 1 x 4,0x89; 1 x 5,0x89; 1 x 6,0x89 ⊕ 851/4 Z PH 1 x PH 1x89; 1 x PH 2x89; 1 x PH 3x89 ⊕ 855/4 Z PZ 1 x PZ 1x89; 1 x PZ 2x89; 1 x PZ 3x89 ⊕ 867/4 Z TORX® BO 1 x TX 10x89; 1 x TX 15x89; 1 x TX 20x89; 1 x TX 25x89; 1 x TX 30x89 ● 8784 A1 1 x 1/4"x1/4"x37,0 ● 8790 HMA ¼" 1 x 4,0x23,0; 1 x 4,5x23,0; 1 x 5,0x23,0; 1 x 5,5x23,0; 1 x 6,0x23,0; 1 x 7,0x23,0; 1 x 8,0x23,0; 1 x 9,0x23,0; 1 x 10,0x23,0; 1 x 12,0x23,0; 1 x 13,0x23,0 ● 8790 HMC ½" 1 x 13,0x37,0; 1 x 14,0x37,0; 1 x 15,0x37,0; 1 x 16,0x37,0; 1 x 17,0x37,0; 1 x 18,0x37,0; 1 x 19,0x37,0; 1 x 21,0x37,0; 1 x 22,0x37,0; 1 x 24,0x37,0 ● 8796 LC 1 x 1/2"x250,0 ● 8796 LA 1 x 1/4"x150,0

Zyklop Mini

La carraca de puntas



EXTRA
SLIM

una geometría
delgada



6°
FINE
TOOTH

un ángulo de
recuperación muy
pequeño



SWITCH

palanca de
reenvío



SPEED

la moleta permite
un apriete o
desapriete rápido



FULL
STEEL

una herramienta
increíblemente
robusta



ULTRA
COMPACT

juegos
compactos





8001 A Carraca de puntas Zyklop Mini de 1/4" y pieza de conexión para llaves de vaso 1/4"

2 piezas

Code		
05073230001	● 8001 A	1 x 1/4"x87,0
	○ 870/1	1 x 1/4"x1/4"x25,0



Bit-Check BR 30 Universal + 8001 A 1/4"

31 piezas

Code		
05073640001	● 8001 A	1 x 1/4"x87,0
	● 889/4/1 K	1 x 1/4"x50,0
	○ 870/1	1 x 1/4"x1/4"x25,0
	● 800/1 TZ	1 x 1,0x5,5x25
	○ 840/1 Z Hex-Plus	1 x 3,0x25; 1 x 4,0x25; 1 x 5,0x25; 1 x 6,0x25; 1 x 8,0x25
	⊕ 851/1 TZ PH	2 x PH 1x25; 3 x PH 2x25; 1 x PH 3x25
	⊕ 855/1 TZ PZ	1 x PZ 1x25; 3 x PZ 2x25; 1 x PZ 3x25
	⊕ 867/1 TZ TORX®	1 x TX 10x25; 1 x TX 15x25; 1 x TX 20x25; 1 x TX 25x25; 1 x TX 30x25; 1 x TX 40x25
	⊕ 867/1 Z TORX® BO	1 x TX 10x25; 1 x TX 15x25; 1 x TX 20x25; 1 x TX 25x25; 1 x TX 30x25



Tool-Check 1

38 piezas

Code		
05073220001	● 8001 A	1 x 1/4"x87,0
	○ 870/1	1 x 1/4"x25
	● 889/4/1 K	1 x 1/4"x50
	⊕ 851/1 TZ PH	2 x PH 1x25; 3 x PH 2x25; 1 x PH 3x25
	⊕ 855/1 TH PZ	1 x PZ 1x25; 3 x PZ 2x25; 1 x PZ 3x25
	⊕ 867/1 Z TORX®	1 x TX 10x25; 1 x TX 15x25; 1 x TX 20x25; 1 x TX 25x25; 1 x TX 30x25; 1 x TX 40x25
	⊕ 867/1 Z TORX® BO	1 x TX 10x25; 1 x TX 15x25; 1 x TX 20x25; 1 x TX 25x25; 1 x TX 30x25
	● 800/1 TZ	1 x 1,0x5,5x25
	○ 840/1 Z Hex-Plus	1 x 3,0x25; 1 x 4,0x25; 1 x 5,0x25; 1 x 6,0x25; 1 x 8,0x25
	● 8790 HMA	1 x 5,5x23,0; 1 x 6,0x23,0; 1 x 7,0x23,0; 1 x 8,0x23,0; 1 x 10,0x23,0; 1 x 12,0x23,0; 1 x 13,0x23,0



Tool-Check PLUS

39 piezas

Code		
05056490001	● 8001 A	1 x 1/4"x87,0
	● 813	1 x 1/4"x78
	● 889/4/1 K	1 x 1/4"x50
	○ 870/1	1 x 1/4"x25
	● 8790 HMA	1 x 5,5x23,0; 1 x 6,0x23,0; 1 x 7,0x23,0; 1 x 8,0x23,0; 1 x 10,0x23,0; 1 x 12,0x23,0; 1 x 13,0x23,0
	⊕ 851/1 TZ PH	2 x PH 1x25; 3 x PH 2x25; 1 x PH 3x25
	⊕ 855/1 TH PZ	1 x PZ 1x25; 3 x PZ 2x25; 1 x PZ 3x25
	⊕ 867/1 Z TORX®	1 x TX 10x25; 1 x TX 15x25; 1 x TX 20x25; 1 x TX 25x25; 1 x TX 30x25; 1 x TX 40x25
	⊕ 867/1 Z TORX® BO	1 x TX 10x25; 1 x TX 15x25; 1 x TX 20x25; 1 x TX 25x25; 1 x TX 30x25
	○ 840/1 Z Hex-Plus	1 x 3,0x25; 1 x 4,0x25; 1 x 5,0x25; 1 x 6,0x25; 1 x 8,0x25
	● 800/1 TZ	1 x 1,0x5,5x25

La gama Zyklop, 1/4"

Flexible-Lock

Cuando este sistema está activado se puede montar la herramienta accesoria de forma fija en la extensión. Así se evita una posible pérdida de la herramienta, ya que ésta no se puede soltar y salir de la conexión. Cuando el sistema está desactivado los vasos se pueden encajar como siempre, y es posible cambiarlos en un instante.



8790 HMA Llave de vaso Zyklop con arrastre de 1/4"

Code						
	mm		mm	mm	mm	mm
05003501001	4.0		23.0	6.9	13.0	10.0
05003502001	4.5		23.0	7.5	13.0	10.0
05003503001	5.0		23.0	8.2	13.0	10.0
05003504001	5.5		23.0	8.8	13.0	10.0
05003505001	6.0		23.0	9.4	13.0	10.0
05003506001	7.0		23.0	11.0	13.0	10.0
05003507001	8.0		23.0	12.0	13.0	10.0
05003508001	9.0		23.0	13.0	14.0	10.0
05003509001	10.0		23.0	14.5	14.5	-
05003510001	11.0		23.0	16.0	15.0	13.0
05003511001	12.0		23.0	17.0	16.0	13.0
05003512001	13.0		23.0	18.0	17.0	13.0
05003513001	14.0		23.0	20.0	18.0	13.0
05003514001		3/16"	23.0	7.5	13.0	10.0
05003515001		7/32"	23.0	8.8	13.0	10.0
05003516001		1/4"	23.0	11.0	13.0	10.0
05003517001		9/32"	23.0	11.0	13.0	10.0
05003518001		5/16"	23.0	12.0	13.0	10.0
05003519001		11/32"	23.0	13.0	14.0	10.0
05003520001		3/8"	23.0	14.5	14.5	-
05003521001		7/16"	23.0	16.0	15.0	13.0
05003522001		1/2"	23.0	18.0	17.0	13.0
05003523001		9/16"	23.0	20.0	18.0	13.0

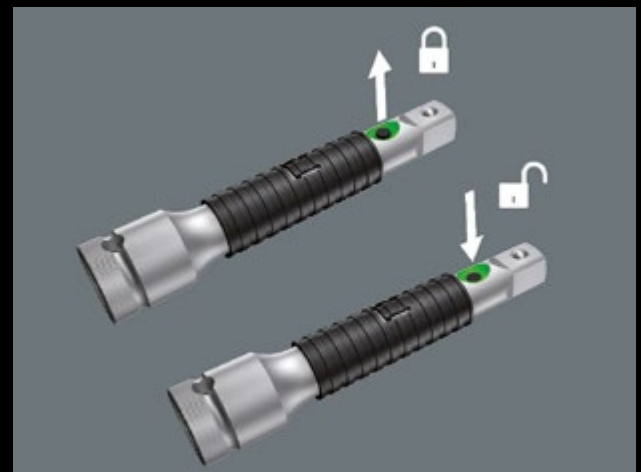

8796 SA Extensión Zyklop "flexible lock" con manguito de giro rápido, versión corta, 1/4"

Code			mm
05003530001	1/4"		75.0



8796 LA Extensión Zyklop "flexible-lock" con manguito de giro rápido, versión larga, 1/4"

Code			mm
05003531001	1/4"		150.0



8789 A Mango Zyklop en "T", 1/4"

Code	mm
05003524001	110.0



8795 A Articulación cardán Zyklop, 1/4"

Code	mm
05003528001	35.5



8794 SA Extensión Zyklop con manguito de giro rápido, versión corta, 1/4"

Code	mm
05003525001	75.0



8794 A Extensión Zyklop tipo "Wobble", 1/4"

Code	mm
05003527001	56.0



8794 LA Extensión Zyklop con manguito de giro rápido, versión larga, 1/4"

Code	mm
05003526001	150.0



8784 A1 Adaptador Zyklop, 1/4"

Code	mm
05003529001	37.0

La gama Zyklop, 3/8"

Los vasos que ahora se llaman "vasos manuales y para máquina", permiten una aplicación tanto en el trabajo manual como en la utilización maquinaria (la utilización con un destornillador de impacto en la mayoría de los casos no se recomienda). De esta forma el usuario economiza el no tener que disponer de dos series de vasos durante el trabajo, siendo de este modo mucho más fácil y cómodo tanto el transporte como el proceso mismo de atornillado.



8790 HMB Llave de vaso Zyklop con arrastre de 3/8"



Code	mm	mm	mm	mm	mm
05003551001	6.0	29.0	10.5	13.0	18.0
05003552001	7.0	29.0	11.0	13.0	18.0
05003553001	8.0	29.0	12.2	13.0	18.0
05003554001	9.0	29.0	13.5	13.0	18.0
05003555001	10.0	29.0	14.5	13.0	18.0
05003556001	11.0	29.0	16.0	13.0	18.0
05003557001	12.0	29.0	17.0	13.0	18.0
05003558001	13.0	29.0	18.5	14.0	20.0
05003559001	14.0	29.0	19.5	14.5	22.0
05003560001	15.0	29.0	21.0	15.0	24.0
05003561001	16.0	30.0	22.0	16.0	24.0
05003562001	17.0	30.0	23.5	17.0	24.0
05003563001	18.0	30.0	24.5	18.0	24.0
05003564001	19.0	30.0	26.0	13.0	24.0
05003565001	20.0	30.0	28.0	13.0	25.0
05003566001	21.0	30.0	28.0	13.0	25.0
05003567001	22.0	30.0	32.0	13.0	25.0
05003568001	24.0	32.0	32.0	13.0	25.0
05003569001	1/4"	29.0	11.0	18.0	12.0
05003570001	5/16"	29.0	12.2	18.0	12.0
05003571001	11/32"	29.0	13.5	18.0	12.0
05003572001	3/8"	29.0	14.5	18.0	12.0
05003573001	7/16"	29.0	16.0	18.0	12.0
05003574001	1/2"	29.0	18.5	20.0	12.0
05003575001	9/16"	29.0	19.5	22.0	12.0
05003576001	5/8"	30.0	22.0	24.0	12.0
05003577001	11/16"	30.0	23.0	24.0	18.0
05003578001	3/4"	30.0	26.0	24.0	18.0
05003579001	13/16"	30.0	28.0	25.0	18.0
05003580001	7/8"	30.0	32.0	25.0	18.0



8796 SB Extensión Zyklop "flexible lock" con manguito de giro rápido, versión corta, 3/8"

Code	mm
05003591001	125.0





8796 LB Extensión Zyklop "flexible-lock" con manguito de giro rápido, versión larga, 3/8"

Code	mm
05003592001	200.0





8789 B Mango Zyklop en "T", 3/8"

Code			mm
05003581001	3/8"	165.0	





8795 B Articulación cardán Zyklop, 3/8"

Code			mm
05003585001	3/8"	50.0	





8794 SB Extensión Zyklop con manguito de giro rápido, versión corta, 3/8"

Code			mm
05003582001	3/8"	125.0	





8794 B Extensión Zyklop tipo "Wobble", 3/8"

Code			mm
05003584001	3/8"	76.0	



8794 LB Extensión Zyklop con manguito de giro rápido, versión larga, 3/8"

Code			mm
05003583001	3/8"	200.0	









8784 B1 Adaptador Zyklop, 3/8"

Code				mm
05003590001	1/4"	3/8"	44.0	

La gama Zyklop, 1/2"





8790 HMC Llave de vaso
Zyklop con arrastre de, 1/2"

Code						
	mm		mm	mm	mm	mm
05003601001	10.0		37.0	15.5	24.0	17.0
05003602001	11.0		37.0	16.5	24.0	17.0
05003603001	12.0		37.0	17.5	24.0	17.0
05003604001	13.0		37.0	19.0	24.0	17.0
05003605001	14.0		37.0	20.0	24.0	17.0
05003606001	15.0		37.0	21.0	24.0	17.0
05003607001	16.0		37.0	22.5	24.0	17.0
05003608001	17.0		37.0	24.0	26.0	17.0
05003609001	18.0		37.0	25.0	26.0	17.0
05003610001	19.0		37.0	26.5	26.0	20.0
05003611001	20.0		37.0	28.0	26.0	20.0
05003612001	21.0		37.0	29.0	26.0	20.0
05003613001	22.0		37.0	30.5	26.0	20.0
05003614001	24.0		37.0	33.0	28.0	20.0
05003615001	27.0		40.0	36.5	32.0	23.0
05003616001	30.0		42.0	40.0	34.0	25.0
05003617001	32.0		42.0	42.0	36.0	25.0
05003618001		3/8"	37.0	15.5	24.0	17.0
05003619001		7/16"	37.0	16.5	24.0	17.0
05003620001		1/2"	37.0	19.0	24.0	17.0
05003621001		9/16"	37.0	20.0	24.0	17.0
05003622001		19/32"	37.0	21.0	24.0	17.0
05003623001		5/8"	37.0	22.5	24.0	17.0
05003624001		11/16"	37.0	25.5	26.0	17.0
05003625001		3/4"	37.0	26.5	26.0	20.0
05003626001		25/32"	37.0	28.0	26.0	20.0
05003627001		13/16"	37.0	29.0	26.0	20.0
05003628001		7/8"	37.0	30.5	26.0	20.0
05003629001		15/16"	37.0	33.0	28.0	20.0
05003630001		31/32"	37.0	33.0	28.0	20.0
05003631001		1"	40.0	36.5	32.0	23.0
05003632001		1 1/16"	40.0	36.5	32.0	23.0
05003633001		1 1/8"	40.0	40.0	34.0	23.0
05003634001		1 3/16"	42.0	40.0	34.0	25.0
05003635001		1 1/4"	42.0	42.0	36.0	25.0

La extensión tipo "Wobble" dispone de un ángulo de lado de 15° en todas las direcciones. De este modo, usted también podrá trabajar en situaciones de estrechez de montaje y de difícil acceso.





8796 SC Extensión Zyklop "flexible lock" con manguito de giro rápido, versión corta, 1/2"

Code			mm
05003642001	1/2"	125.0	



8796 LC Extensión Zyklop "flexible-lock" con manguito de giro rápido, versión larga, 1/2"

Code			mm
05003643001	1/2"	250.0	



8789 C Mango Zyklon en "T", 1/2"

Code	mm
05003638001	250.0



8795 C Articulación cardán Zyklon, 1/2"

Code	mm
05003640001	69.0



8794 SC Extensión Zyklon con manguito de giro rápido, versión corta, 1/2"

Code	mm
05003637001	125.0



8794 C Extensión Zyklon tipo "Wobble", 1/2"

Code	mm
05003639001	52.0



8794 LC Extensión Zyklon con manguito de giro rápido, versión larga, 1/2"

Code	mm
05003638001	250.0



8784 C2 Adaptador Zyklon, 1/2", 5/16"

Code	mm
05003641001	50.0

Koloss

¡Carraca y martillo a la vez!



función de
martillo

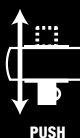

cuadrado
pasante



construcción de
doble trinquete



Todos lo habremos hecho alguna vez: utilizar la carraca de martillo de manera inapropiada, sólo para ganar tiempo. Está prohibido, y sin embargo, pasa muy frecuente. Pero, esto ahora ya no hace falta: Para eso está el nuevo Koloss de Wera. Se trata de la primera carraca en el mundo que también se puede utilizar correctamente como martillo.

El Koloss sirve de carraca de inversión, así como de carraca de altas cargas con una capacidad de al menos 600 newtonmetros. El dentado de trinquete doble, así como el reducido ángulo de retorno de tan sólo 6°, permiten un trabajo de atornillamiento incluso en situaciones de montaje sumamente estrechas.



8002 C Koloss, 1/2"

Code		
05073232001	8002 C	1 x 1/2"x341,0
	8782 C	1 x almohadilla protectora
	Bolsa	1 x



8780 C Barra de prolongación Koloss

Code	mm
05003695001	341,0



8781 C Mandril centrador Koloss

Code	mm	mm	mm
05003696001	135,0	85,0	5,3-18,0



8002 C Koloss All Inclusive Set con arrastre de 1/2"

Code		
05133862001	8002 C	1 x 1/2"x341,0
	8782 C	1 x almohadilla protectora
	8780 C	1 x Prolongación
	Perno de desbloqueo	1 x
	Bolsa	1 x



8782 C Juego de almohadillas protectoras Koloss

Code		
05003697001	8782 C	2 x 50,0x50,0



Wera Werk · Germany
Korzerter Straße 21–25
D-42349 Wuppertal

Phone: +49 (0)2 02/40 45-322
Fax: +49 (0)2 02/40 36 34
E-Mail: info@wera.de

www.wera.de